

### Product Identification and Overview

BAPI's Carbon Monoxide Sensor offers enhanced electrochemical sensing with outstanding accuracy at low concentrations. The Duct unit samples duct air using an aspiration tube. The Rough Service unit features a ventilated BAPI-Box and is ideal for parking ramps, equipment rooms and warehouses.

The sensor has field selectable CO ranges of 0 to 100, 0 to 200, 0 to 300 and 0 to 500 ppm. It also has field selectable outputs of 0 to 5, 1 to 5, 0 to 10, 2 to 10 VDC and 3-wire 4 to 20 mA output. The large LCD is backlit for 10 seconds after any button push.

Two independent SPDT alarm contacts switch at field selectable CO concentrations of 25, 35, 50, 100 and 200 ppm. An alarm timer can hold the output relays on for one to ten minutes after the CO level has fallen below 80% of setpoint. This allows additional fan run time to be sure that the CO has been purged. The field replaceable sensor element lasts approximately 7 years and is self tested daily.

Note: There is a small heart symbol in the top right corner of the display that blinks every 1/2 second. This heartbeat indicates that the unit is operating correctly.

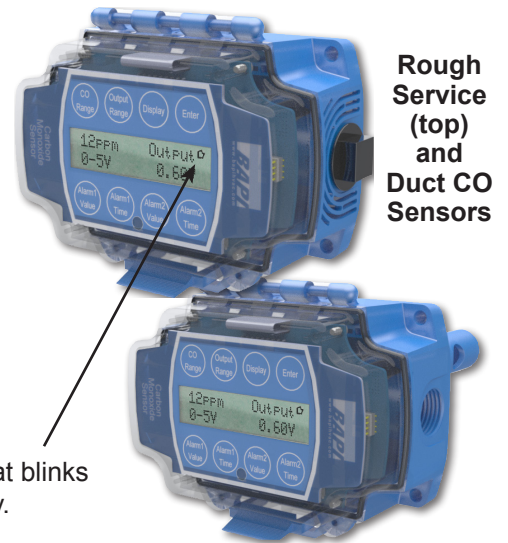

### Mounting

#### Rough Service Ventilated Unit

1. Mount the unit on a solid, non-vibrating surface 3 to 5 feet above floor level. Mount in a horizontal orientation with the enclosure hinge at the top as shown in Fig 2. Failure to do so may degrade the life of the sensor element. Do not mount near supply or return diffusers.
2. Use BAPI recommended #10 (M5) screws on the four mounting feet of the enclosure. A pilot-hole makes mounting easier. Use the enclosure mounting feet to mark the pilot-hole locations.
3. Snug up the screws so that the foam backing is depressed but do not over-tighten or strip the screw threads.
4. Place the provided #6 screws into the holes on each site of the lid latch to make the cover tamper resistant.

#### Duct Aspiration Tube Unit

1. BAPI recommends placing the sensor in the middle of the duct wall, away from stratified air, to achieve the best reading. The unit should also be a minimum of 3 duct diameters from an elbow, damper or other duct restriction.
2. Drill a 1" hole for the aspiration probe. Position the box so that airflow is directly into the holes on one side of the aspiration probe. The air direction is not important.
4. Mount the enclosure to the duct using BAPI recommended #10 screws through a minimum of two mounting feet on opposite corners. A 1/8" pilot hole makes mounting easier. Use the mounting feet to mark the pilot-hole locations.
5. Snug the screws until the foam backing is compressed about 50% to prevent air leakage but do not over-tighten.
6. Use the provided #6 screws to secure the cover for IP66 rating.
7. BAPI recommends sealing the conduit opening with fiberglass insulation.

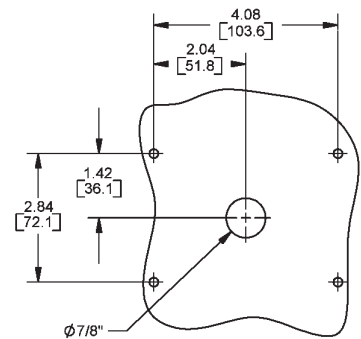

**Fig. 1: Screw Hole Template.** Drill center 7/8" hole for rear conduit entry on Rough Service Unit. Drill 1" hole for Aspiration Tube on Duct Unit

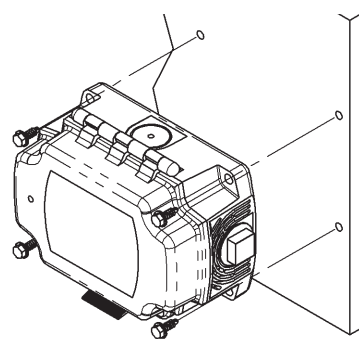

**Fig. 2: Rough Service Unit mounting**

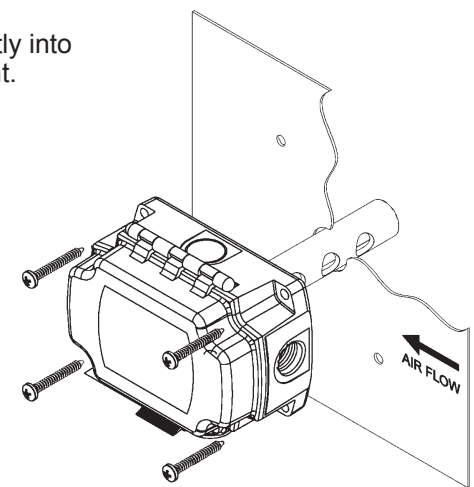

**Fig. 3: Duct Unit mounting**

Specifications subject to change without notice.

## Termination

BAPI recommends using twisted pair of at least 22AWG and sealant filled connectors for all wire connections. Larger gauge wire may be required for long runs. All wiring must comply with the National Electric Code (NEC) and local codes.

Do NOT run this device's wiring in the same conduit as AC power wiring of NEC class 1, NEC class 2, NEC class 3 or with wiring used to supply highly inductive loads such as motors, contactors and relays. BAPI's tests show that fluctuating and inaccurate signal levels are possible when AC power wiring is present in the same conduit as the signal lines. If you are experiencing any of these difficulties, please contact your BAPI representative.



BAPI recommends wiring the product with power disconnected. Proper supply voltage, polarity and wiring connections are important to a successful installation. Not observing these recommendations may damage the product and void the warranty.

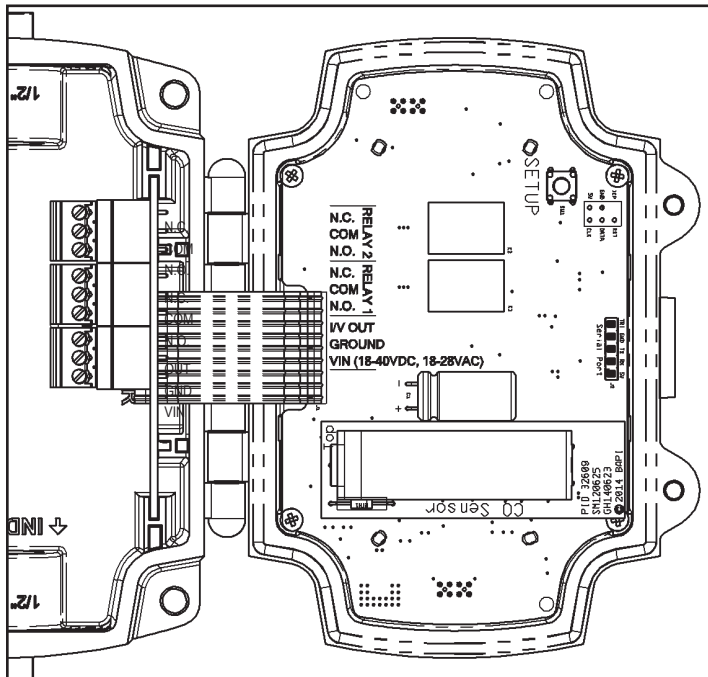

Fig. 4: Field Wiring Terminals

## WIRING TERMINALS

### VIN – Input Power

18 to 28 VAC, 7.2 VA Max  
18 to 40 VDC, 180 mA Max.

### GROUND:

Power and Analog Output Ground

### I/V OUT

Three wire voltage or current signal

### RELAYS

Relay contacts are galvanically isolated. They are not connected to each other, or to circuit power or ground in the carbon monoxide transmitter.

**N.O.** – Normally Open Contact

**COM** – Common Contact

**N.C.** – Normally Closed Contact

NOTE: The connectors that plug into the jacks on the board use a rising block screw terminal to hold the wires. If the block is in a partially up position, the wire may be inserted under the block and the wire will not be held when the screw is tightened. To avoid improper wiring, turn the male connector screws counterclockwise until the block is below the wire opening before inserting the wire. Lightly tug on each wire after tightening to verify proper termination.

## Keeping the Enclosure Air Tight After Termination

For the sensor to work correctly, the wiring entrance must remain air tight. If the CO transmitter is mounted to a hollow wall and wired through its back, or wired with conduit, it is possible that a draft of clean air may fill the enclosure through the wiring opening. This draft may prevent the unit from measuring ambient Carbon Monoxide. BAPI recommends either a liquid-tight fitting or plugging the conduit at the enclosure.

- **Liquid-Tight Fitting** – BAPI's Liquid-Tight Fitting (BA/LTF) allows wire cables of 0.1 to 0.3 inch outside diameter to enter the box. Tightening the collar onto the wire cable keeps the wiring entrance air tight.

- **Conduit** – Included with the Carbon Monoxide transmitter is a foam plug to seal the ½ inch EMT. Place the wires into the plug as shown in Fig. 5 and then insert the plug into the conduit sealing the conduit.

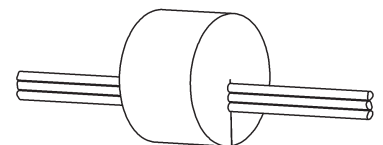
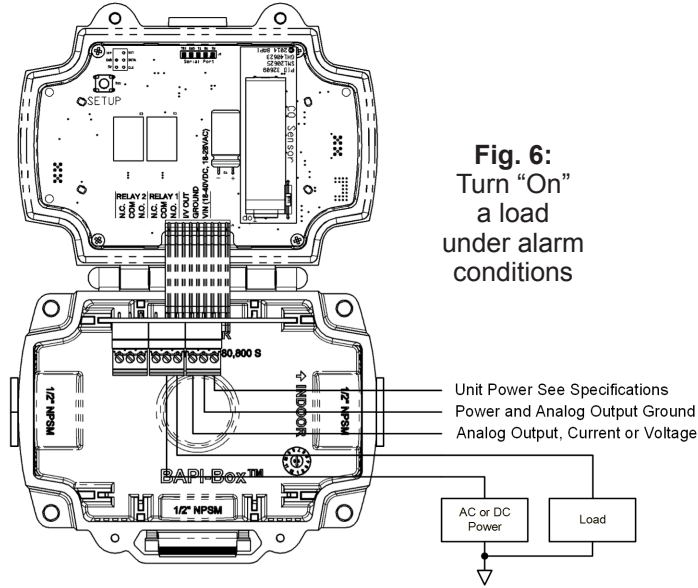

Fig. 5:  
Wires Through Foam Plug

### Relay Load Termination

The Alarm Relays may be used to switch a load on or off. Fig. 6 shows a circuit that may be used to switch on a load under alarm conditions. Fig. 7 shows a circuit that may be used to switch off a load under alarm conditions. For clarity only Alarm Relay 1 is shown, Alarm Relay 2 may be used in the same way.



**Fig. 6:**  
Turn "On"  
a load  
under alarm  
conditions

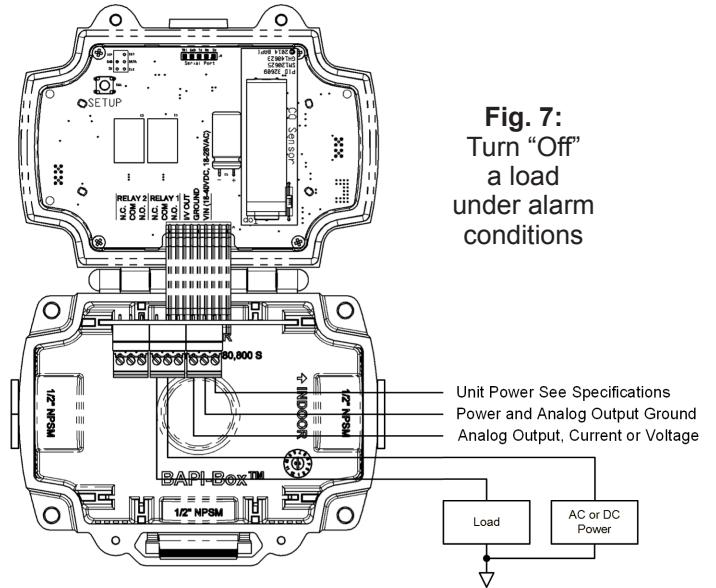

**Fig. 7:**  
Turn "Off"  
a load  
under alarm  
conditions

Fig. 8 shows how two or more Carbon Monoxide Transmitters may be interconnected to switch a load. This example shows how to turn on a load under alarm conditions. Similar circuitry may be used to turn off a load under alarm conditions. Fig. 8 connects together the Normally Open terminals of Alarm Relay #1 in both units and connects them to the load. Fig. 8 also connects together the Common terminals of Alarm Relay #1 in both units and then connects them to the load's power. This wiring circuit will drive the load whenever any one of the Carbon Monoxide Transmitters is in an alarm condition. *Note: Be sure to only connect similar terminals from each unit (Normally Open terminal to Normally Open terminal, etc.). Cross connecting any of the terminals (Normally Closed to Common, etc.) may damage the units and may void the warranty.*

For clarity only Alarm Relay 1 is shown in the example below. Alarm Relay 2 may be used in the same way.

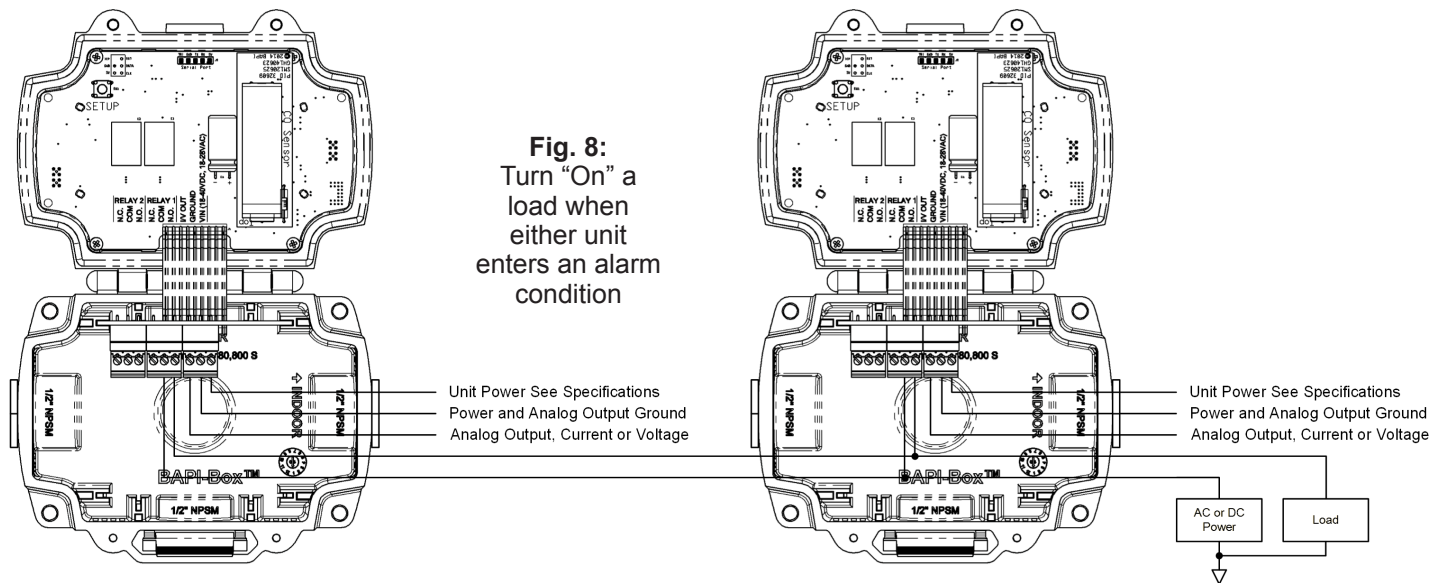
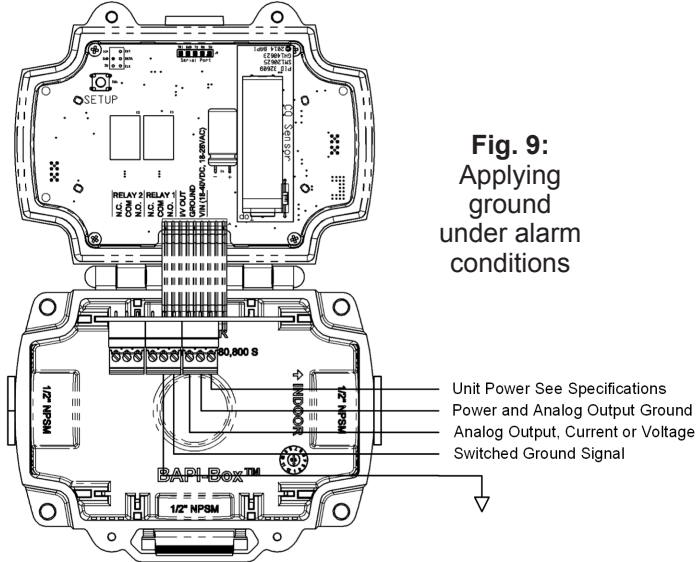

**Fig. 8:**  
Turn "On" a  
load when  
either unit  
enters an alarm  
condition

Specifications subject to change without notice.

### Relay Load Termination continued...

Some circuits require a switched ground to operate, such as audible alarms, visual alarms, or large AC motor controllers. Fig. 9 shows how to apply ground under an alarm condition. Fig. 10 shows how to remove ground under an alarm condition. For clarity only Alarm Relay 1 is shown. Alarm Relay 2 may be used in the same way.



**Fig. 9:**  
Applying ground under alarm conditions

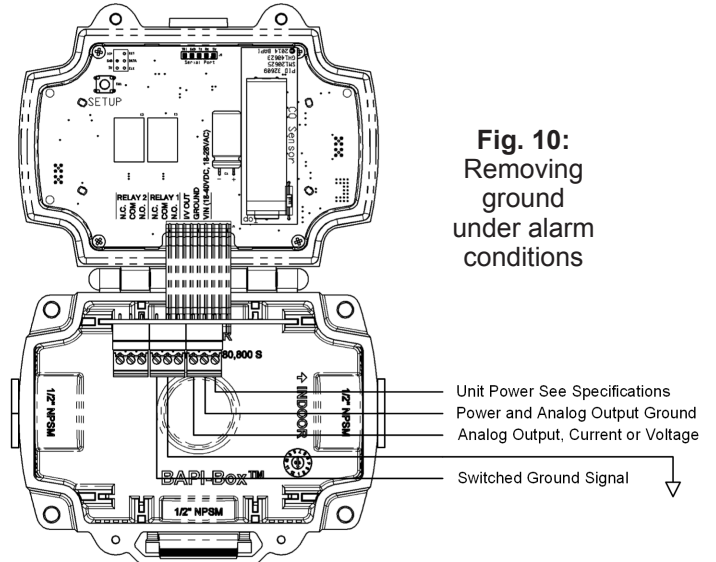

**Fig. 10:**  
Removing ground under alarm conditions

### Power Up

During the first 60 seconds after applying power, the Carbon Monoxide Transmitter performs the following functions:

- Front panel capacitive button test;
- Displays the transmitter's software version number;
- Displays the transmitter's serial number;
- Displays the transmitter's run time;
- Displays the CO Module's software version number;
- Displays the CO Module's serial number;
- Displays the CO Module's run time;
- Performs a CO Module self-test;

When the CO Module self-test is complete, the transmitter is operational.

### Operation

The eight buttons on the face of the unit sense the user's fingertip when pressed against the plastic cover. The buttons allow the user to review or select unit configuration parameters. The top line of the display continues to show the CO measurement when reviewing or selecting parameters.

Parameter Button	Function
	Review or select Carbon Monoxide measurement range used for analog output
	Review or select analog output range
	Review or select display on or display off
	View hidden values, verify edit mode, save edited configuration parameters, or end configuration parameter edit
	Review or select CO concentration to enable Alarm 1 relay
	Review or select number of minutes that Alarm 1 relay stays on after CO dissipates
	Review or select CO concentration to enable Alarm 2 relay
	Review or select number of minutes that Alarm 2 relay stays on after CO dissipates



### Operation continued...

#### Display On and Display Off Modes

The top line of the display shows the CO measurement when the Display Mode is set to "On". If the Display Mode is set to "Off," the top line of the display shows the word "On" rather than the CO measurement. If the CO measurement is below Alarm 1 or Alarm 2 levels, the LED will be green.

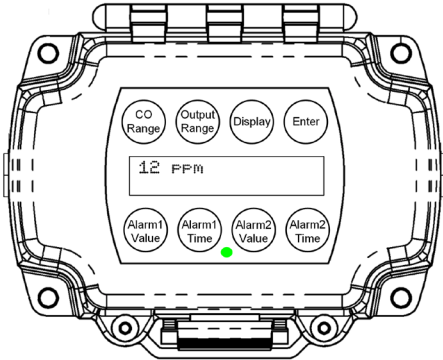

Display "On" Mode

**Fig. 11:**  
Display During Normal Operation  
(Reading is below CO alarm value)

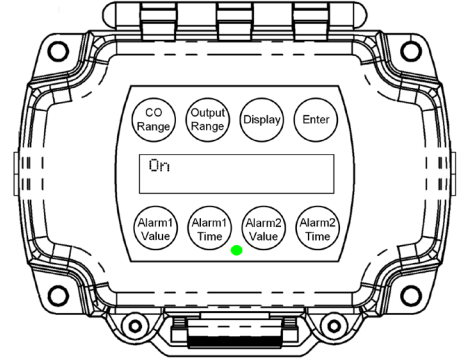

Display "Off" Mode

#### Displaying the CO Measurement, Analog Output Range and Analog Output Value

Touching the Enter button displays the Current Reading, the Analog Output Range and Analog Output Value for 10 seconds. The current reading is replaced by the word "On" if the display is set to "Off".

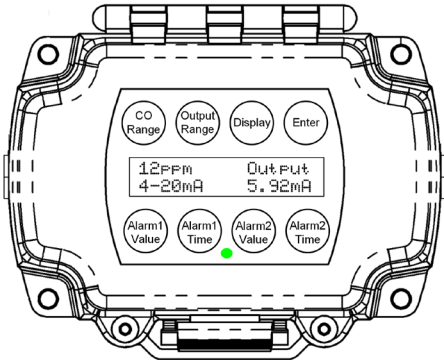

4 to 20 mA Output Mode  
(Display set to "On")

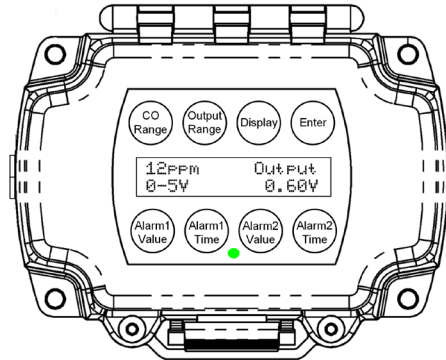

0 to 5 Volt Output Mode  
(Display set to "On")

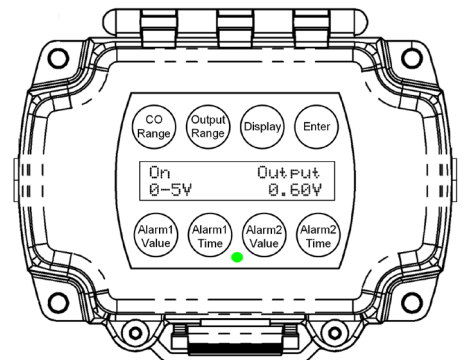

0 to 5 Volt Output Mode  
(Display set to "Off")

**Fig. 12:** Display showing the Current Reading, the Analog Output Range and Analog Output Value

#### CO Sensor Failure Display

The CO sensor element is tested for proper operation daily. If the sensor fails:

- The top line of the display displays "Replace Sensor,"
- The analog output is set to 100% of range
- Both relays turn on,
- The LED flashes yellow.

Note: The sensor failure display is the same whether the display is set to "On" or "Off".

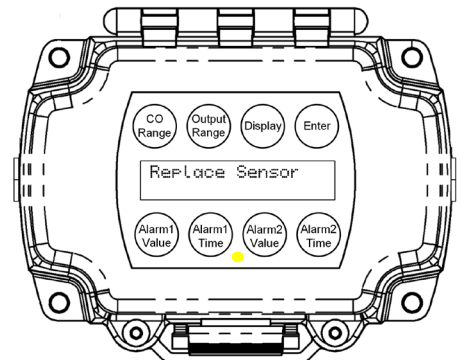

**Fig. 13:** CO Sensor Failure

**Operation continued...**

### Alarm Condition 1 Display

If the CO measurement exceeds the Alarm 1 setpoint:

- The CO measurement or the word “On” is displayed on the first line
- The alarm condition is displayed on the second line
- The LED will be red
- The backlight flashes

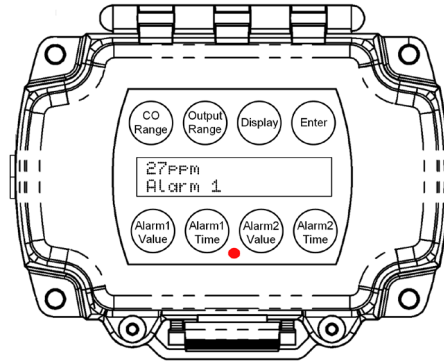

Alarm Condition 1  
(Display set to “On”)

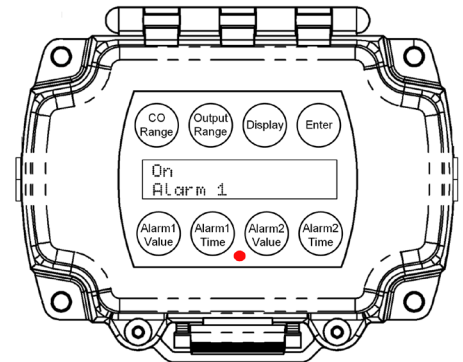

Alarm Condition 1  
(Display set to “Off”)

**Fig. 14:** Display when the measurement exceeds Alarm Condition 1 Setpoint

### Alarm Condition 2 Display

If the CO measurement exceeds the Alarm 2 setpoint;

- The CO measurement or the word “On” is displayed on the first line
- The alarm condition is displayed on the second line
- The LED will be red
- The back light flashes

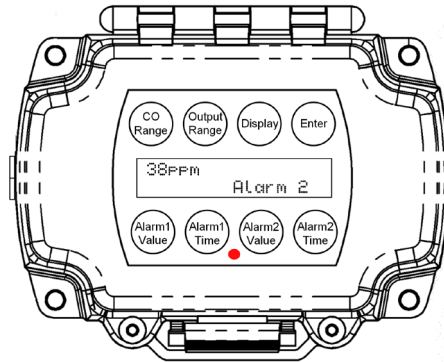

Alarm Condition 2  
(Display set to “On”)

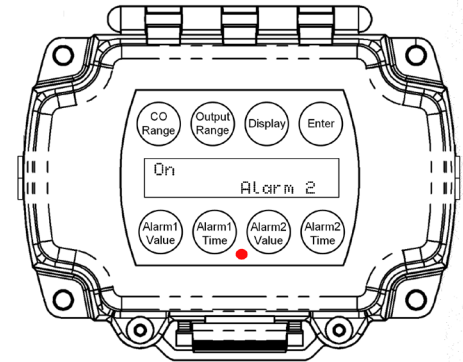

Alarm Condition 2  
(Display set to “Off”)

**Fig. 15:** Display when the measurement exceeds Alarm Condition 2 Setpoint

### Alarm Condition 1 & 2 Display

If the CO measurement exceeds the Alarm 1 & 2 setpoint;

- The CO measurement or the word “On” is displayed on the first line
- The alarm condition 1 and 2 is displayed on the second line
- The LED will be red
- The back light flashes

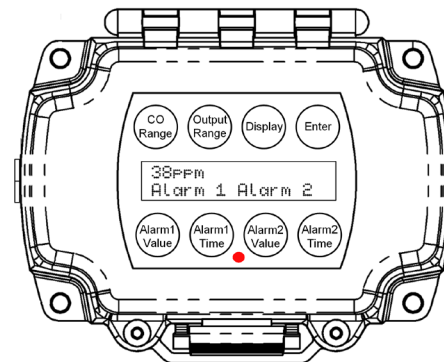

Alarm Condition 1 & 2  
(Display set to “On”)

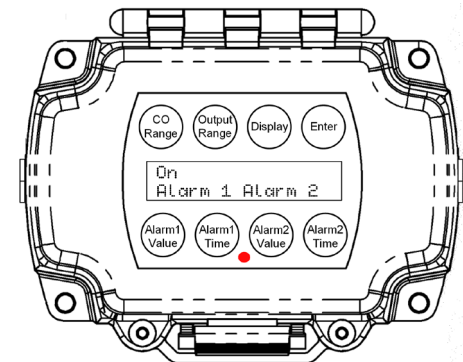

Alarm Condition 1 & 2  
(Display set to “Off”)

**Fig. 16:** Display when the measurement exceeds Alarm Condition 1 & 2 Setpoint

Note: The Alarm 2 Setpoint may be equal to, greater than or less than the Alarm 1 Setpoint.

### Reviewing Parameter Settings

You can review the parameter settings at any time during normal operation by touching any of the eight buttons on the face of the unit. The following figures show a typical display when a button is touched. The values will display for 10 seconds and then the display will revert to normal.

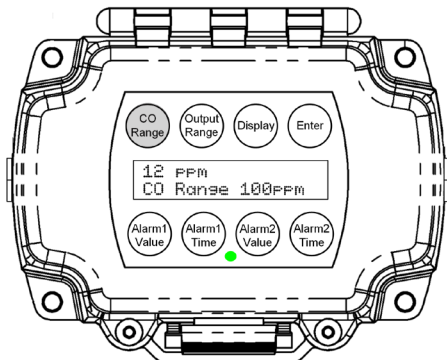

CO Range

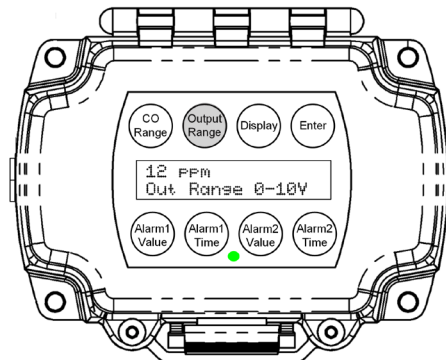

Output Range (0 to 10 Volts)

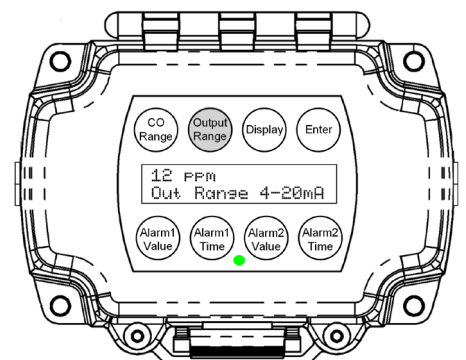

Output Range (4 to 20mA)

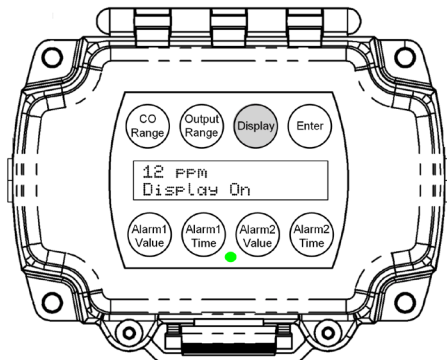

Display Mode

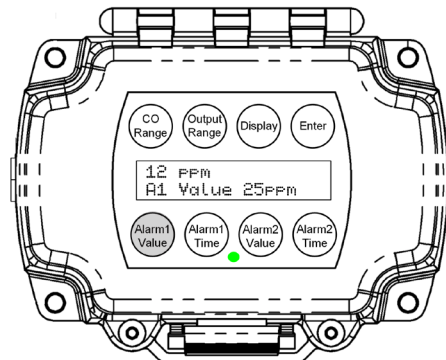

Alarm 1 Value

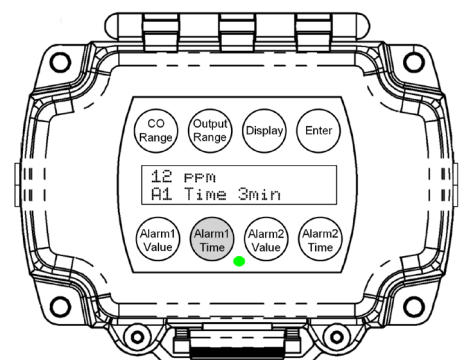

Alarm 1 Time

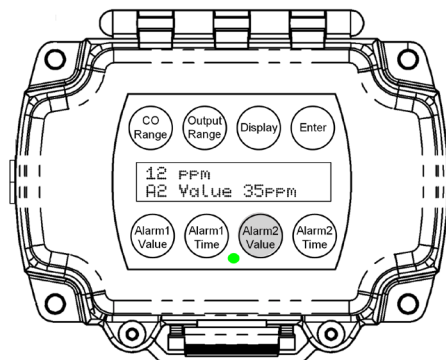

Alarm 2 Value

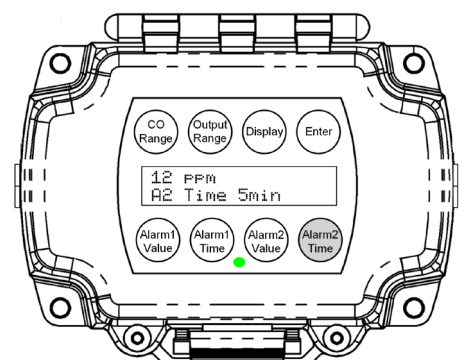

Alarm 2 Time

### Parameter Setup and Default Settings

If field personnel wish to change any parameter settings, they must remove the tamper resistant screws, open the cover, and press the switch on the board labeled "Setup." Follow Fig. 17 below to change parameters.

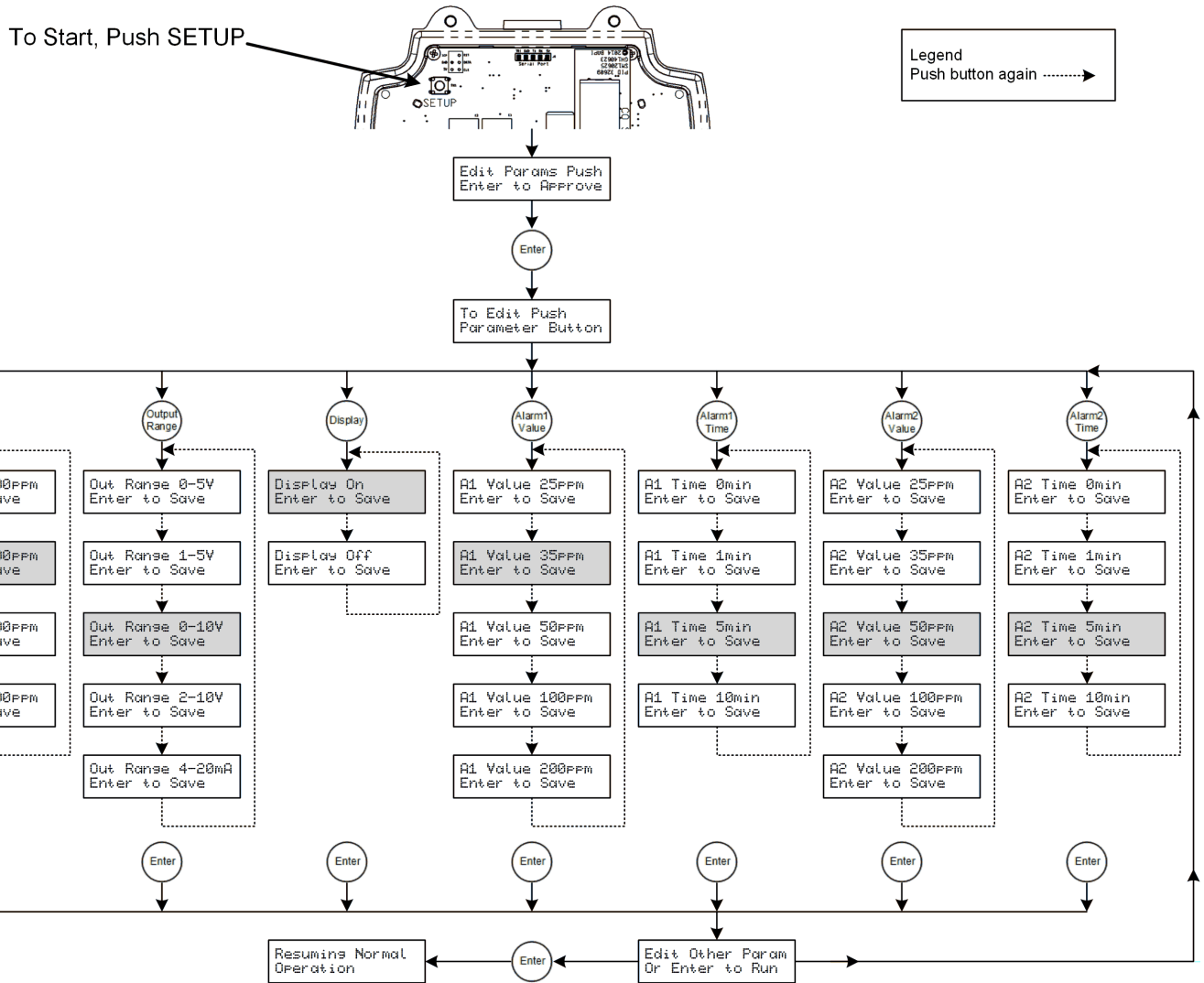

**Fig. 17:**  
Parameter Setup Flow Chart  
(Default settings are shown with gray shading)



### Calibration

Every BAPI Carbon Monoxide Transmitter is factory calibrated. Each unit is ready for operation after installation and the 60 second start-up time.

BAPI's factory calibrated CO sensing element is not capable of field calibration. BAPI recommends replacing the sensor whenever the Replace Sensor alarm is active, or every 7 years, or at the recalibration intervals required by the local jurisdiction. The sensing element comes supplied factory equipped with calibration certificate.

To replace the CO Module (Fig. 18), follow these steps;

- Remove the tamper resistant screws and open the lid
- Unplug the power connector
- For the next two steps, hold the sensor by the body, not the endcaps.
- Remove the CO Module by pulling it straight off the transmitter
- Plug in the new sensor by pushing the sensor board straight into the transmitter
- Plug in the power connector
- Close the lid until it clicks, and replace the tamper resistant screws

### Maintenance

The BA/CO sensor/transmitter unit should be vacuumed clean once a year or more, depending on the rate of accumulation of any dust or dirt. To avoid sensor damage, the unit MUST NOT be submerged in any liquids. Hosing or splashing of the unit with any liquids must also be avoided and may void the warranty.

The sensor in the Carbon Monoxide Transmitter typically has a life of over 7 years. When the sensor reaches the end of its useful life, the transmitter will alarm when a replacement is required. Factory calibrated replacement sensors are available from BAPI.

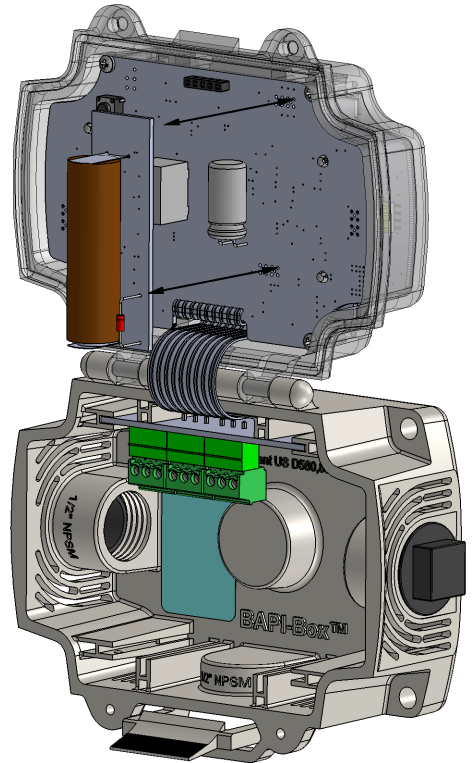

**Fig. 18:**  
Inserting or Removing the  
Sensor Module

### Specifications

**Power:**

18 to 28 VAC, 7.2 VA Max  
18 to 40 VDC, 180 mA Max

**Field Selectable Ranges:**

0 to 100, 0 to 200, 0 to 300 & 0 to 500 ppm

**Sensor Element Life:** 7 Years Typical

**Alarm Relays:**

2 Independent, Dry SPDT (Form C)  
2 Amps at 24 VAC/DC, Resistive  
140 VA Inrush, 48 VA Holding at 24 VAC

**Field Wiring Terminals:**

Pluggable Screw Terminals, 14 to 24 AWG

**Response Time:**

<80 seconds from 10% to 90% of range

**Alarm Relay Setpoints:**

25, 35, 50, 100 or 200 ppm

**Alarm Timer:** 0, 1, 5 & 10 minutes

**Field Selectable Outputs:**

3-wire 4 to 20 mA  
0 to 5 VDC, 1 to 5 VDC  
0 to 10 VDC, 2 to 10 VDC

**Accuracy:**

<200ppm =  $\pm 3\%$  FS, 32 to 122°F (0 to 50°C)  
201 to 500 ppm =  $\pm 5\%$  FS, 50 to 122°F (10 to 50°C)

**Environmental Operation Range**

14 to 122°F (-10 to 50°C)  
5 to 95%RH Noncondensing

See BAPI's Application Notes on our website for further information about coverage area and mounting. Go to [www.bapivac.com](http://www.bapivac.com) and select "Resource Library". Click on "Application Notes", then "Air Quality Related", and choose the link titled "Coverage Area and Mounting Recommendations for BAPI Indoor Air Quality Sensors".



# Duct and Rough Service Carbon Monoxide Sensor

Installation & Operating Instructions

34612\_ins\_CO\_V\_BB

rev. 10/11/17

## Diagnostics

### POSSIBLE PROBLEMS:

General troubleshooting

### POSSIBLE SOLUTIONS:

- Determine that the input is set up correctly in the controller's and building automation software.
- Check wiring for proper termination
- Check for corrosion at either the controller or the sensor. Clean off the corrosion, re-strip the interconnecting wire and reapply the connection. In extreme cases, replace the controller, interconnecting wire and/or sensor.
- Label the terminals that the interconnecting wires are connected to at the sensor end and the controller end. Disconnect the interconnecting wires from the controller and the sensor. With the interconnecting wires separated at both ends, measure the resistance from wire-to-wire with a multimeter. The meter should read greater than 10 Meg-ohms, open or OL depending on the meter you have. Short the interconnecting wires together at one end. Go to the other end and measure the resistance from wire-to-wire with a multimeter. The meter should read less than 10 ohms (22 gauge or larger, 250 feet or less). If either test fails, replace the wire.

Unit does not operate

- Cycle power.
- Check power for proper polarity.
- Disconnect the power wires at the controller and measure the voltage coming from the power source. If the voltage is outside the limits specified on page 1, troubleshoot the power source. Reconnect power wires to controller when finished
- Disconnect the power wires at the sensor and measure the wires for the same voltage as at the controller. If the voltage is different from that measured at the source, troubleshoot the wire. Reconnect power wires to sensor when finished.
- Measure the power at the sensor with the power wires connected to the power source. If the voltage is outside the limits specified on page 9, call your BAPI representative.

## ADDITIONAL DISPLAY MESSAGES AND INDICATION

Display Message	LED	Indication
Module not found retrying	Solid Red	Sensor Module is loose or missing. Securely plug in a sensor module
mA Output Fault	Flashing Red	Unit is configured for mA output, but the loop resistance is incorrect. Troubleshoot connection.
V Output Fault	Flashing Red	Unit is configured for voltage output, but the output voltage is incorrect. Troubleshoot connection
Replace Sensor	Flashing Yellow	Sensor Module failed self-test, replace the sensor module
Self-Test	Solid Yellow	Sensor Module is performing a self-test

Note: If you are experiencing any other problems besides those described above, contact your BAPI representative.